

Elastic Light Scattering

Gabriel Popescu

University of Illinois at Urbana-Champaign
Beckman Institute

Quantitative Light Imaging Laboratory
<http://light.ece.uiuc.edu>



Light Scattering by Inhomogeneous Media

- “Scattering” is a generic term for the interaction of radiation by potentials.
- Neutron scattering on mass (nuclei)
- X-ray scattering on charge (\bar{e})
- Scattering of an electromagnetic field on “scattering potentials” i.e. dielectric inhomogeneous



5.1 Scattering on Single Particles

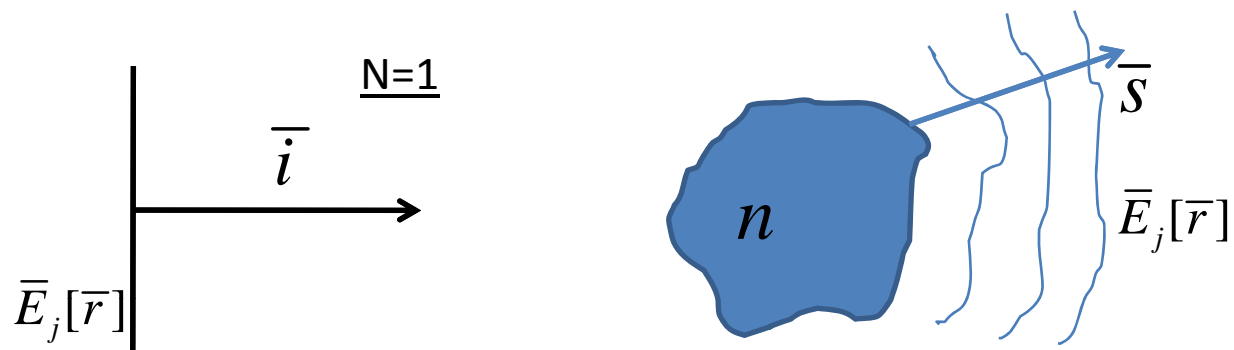

- Direct Problem: given $n[\vec{r}]$, what is $E[\vec{s}]$?
- Inverse Problem: given $E[\vec{s}]$, what is $n[\vec{r}]$?
- This problem is more difficult but it provides a diagnosis tool

$$\vec{E}_j[r] = \vec{E}_0 \cdot e^{i \cdot \vec{k} \cdot \vec{n}} = \text{plane wave incident}; \quad |\vec{k}| = \frac{2\pi}{\lambda} \quad (5.1)$$



5.1 Scattering on Single Particles

- Particles can be characterized by a complex dielectric constant

$$\varepsilon[\vec{r}] = \text{Re}[\varepsilon[\vec{r}]] + i \text{Im}[\varepsilon[\vec{r}]] \quad (5.2)$$

$$\varepsilon(r) = n^2(r) \quad (5.3)$$

- Recall:

- $\text{Re}[n] \rightarrow$ Refraction

- $\text{Im}[n] \rightarrow$ Absorption

- The scattered “far” field ($R > \frac{d^2}{\lambda}$)

$$\vec{E}_s[\vec{r}] = \vec{E}_0 \cdot \frac{e^{i \cdot k \cdot R}}{R} \cdot f[\vec{s}, \vec{i}] \quad (5.4)$$

$f[\vec{s}, \vec{i}] =$ scattering amplitude

= defines amplitude, phase, and polarization of the scattered field.



5.1 Scattering on Single Particles

- Differential Cross section

$$\sigma_d[\bar{s}, \bar{i}] = \lim_{R \rightarrow \infty} [R^2 \left| \frac{\bar{S}_s}{\bar{S}_i} \right|] = |f[\bar{s}, \bar{i}]|^2 \quad (5.5)$$

- Only defined in far-field
- \bar{S}_i and \bar{S}_s are the Pointing vectors (incident and scattered.)

$$\begin{cases} S_{i,s} = \frac{1}{2\eta} |\bar{E}_{i,s}|^2 \\ \eta = \sqrt{\frac{\mu}{\epsilon}} = \text{impedance} \quad (\eta_{vacuum} = 377 \Omega) \end{cases} \quad (5.6)$$

- From (eq. 5.5) differential cross-section:

$$\begin{aligned} \sigma_b &= \sigma_d[-\bar{i}, \bar{i}] \\ &= \text{back scattering section} \end{aligned} \quad (5.7)$$



5.1 Scattering on Single Particles

- Scattering Cross section

$$\sigma_s = \int_{4\pi} \sigma_d[\bar{s}, \bar{i}] d\Omega \quad (5.8)$$

$[\sigma_s] = m^2 = \text{area} = \text{meaning of probability of scattering}$

- Phase Function

$$p[\bar{s}, \bar{i}] = 4\pi \frac{\sigma_d[\bar{s}, \bar{i}]}{\sigma} = 4\pi \frac{|f[\bar{s}, \bar{i}]|^2}{\sigma} \quad (5.9)$$

$$\int p[\bar{s}, \bar{i}] d\Omega = 4\pi = \text{normalization}$$



5.1 Scattering on Simple Particles

- In the presence of absorption

$$\sigma = \sigma_a + \sigma_s = \text{Total Cross Section Area} \quad (5.10)$$

- Most of the time we use “spherical” particles approximation.
- Various regimes, depending on $\frac{a}{\lambda}$ and (n-1): Rayleigh Scattering, Rayleigh-Gans, Mie
- Collection of particles: density is important
- Again various regimes: single scattering, multiple scattering, and diffusion.



5.2 Rayleigh Scattering

- If $a \ll \lambda$, the dipole approximation works well
- Scattering Amplitude

$$\epsilon = n^2$$

$$f[\bar{s}, \bar{i}] = \frac{k^2}{4\pi} \left[\frac{3(\epsilon_r - 1)}{\epsilon_r + 2} \right] \cdot V \cdot [-\bar{s} \times (\bar{s} \times \bar{i})] \quad (5.11)$$

- It describes the “doughnut” shape

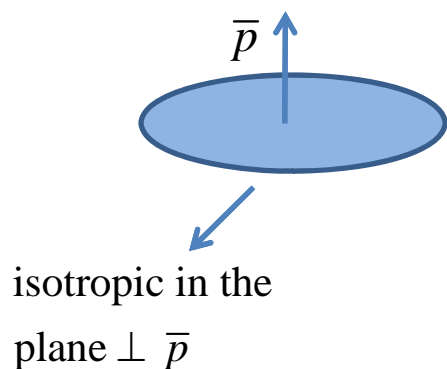

\bar{p} = induced
dipole moment
(recall Lorentz model)

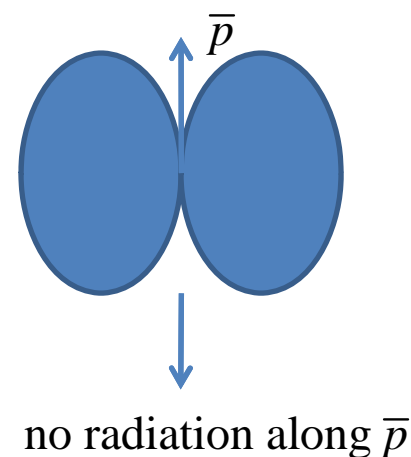



5.2 Rayleigh Scattering

- Question: is the sky polarized?

$$\sigma_s = \pi a^2 \frac{8(ka)^4}{3} \cdot \left| \frac{(\epsilon_r - 1)}{\epsilon_r + 2} \right|^2 \quad (5.12)$$

- Note:

$$\sigma \sim k^4 \propto \frac{1}{\lambda^4} \Rightarrow \text{small } \lambda \text{ scatter more} \Rightarrow \text{blue sky}$$

$$\sigma_s \sim a^6 = V^2$$



5.3 The Born Approximation

- Recall the Helmholtz equation (Chapter 2, eq. 2.50)

$$\nabla^2 U[\vec{r}, \omega] + k^2 n^2[\vec{r}, \omega] U[\vec{r}, \omega] = 0$$
$$k = \frac{2\pi}{\lambda}; \quad \varepsilon = n^2 \quad (5.13)$$

- Scalar eq. is good enough for our purpose
- The Scattering Potential

$$F[\vec{r}, \omega] = \frac{1}{4\pi} k^2 \cdot (n^2[\vec{r}, \omega] - 1) \quad (5.14)$$

=> Equation 5.13 can be rewritten:

$$\nabla^2 U[\vec{r}, \omega] + k^2 U[\vec{r}, \omega] = -4\pi F[\vec{r}, \omega] \cdot U[\vec{r}, \omega] \quad (5.15)$$



5.3 The Born Approximation

- Scattering and diffraction are essentially the same thing : the interaction of light with a (usually small) object.
- So the solution of (eq. 5.15) is a convolution of the impulse response with $F[\bar{r}, \omega] \cdot U[\bar{r}, \omega]$:

$$U^{(s)}[\bar{r}, \omega] = \int_{(V)} F[\bar{r}', \omega] \cdot U[\bar{r}', \omega] \cdot \frac{e^{ik \cdot |\bar{r} - \bar{r}'|}}{|\bar{r} - \bar{r}'|} d^3 r' \quad (5.20)$$

= superposition of wavelets

- Assuming the plane wave incident $U^{(i)} = e^{ik \cdot \bar{s}_0 \cdot \bar{r}}$, the total field in the far zone:

$$U[\bar{r}, \omega] = e^{ik \cdot \bar{s}_0 \cdot \bar{r}} + \int_{(V)} F[\bar{r}', \omega] \cdot U[\bar{r}', \omega] \cdot \frac{e^{ik \cdot |\bar{r} - \bar{r}'|}}{|\bar{r} - \bar{r}'|} d^3 r' \quad (5.21)$$



5.3 The Born Approximation

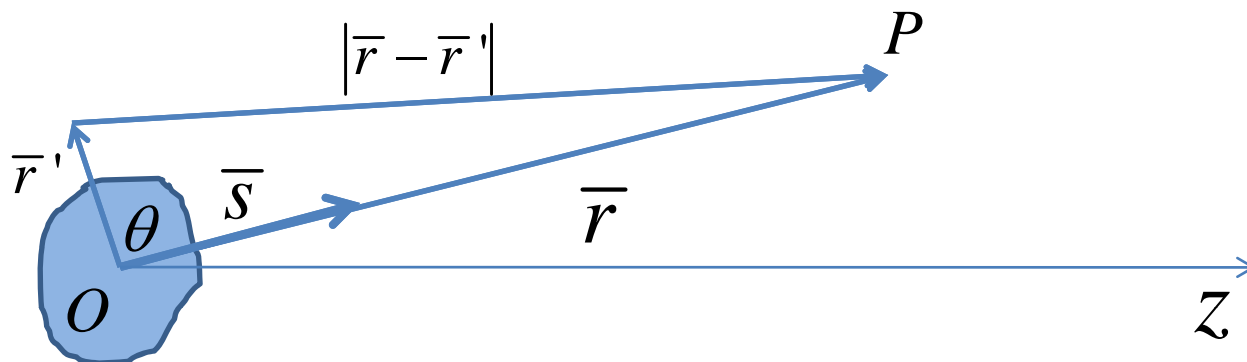

- Useful Approximation (for zone)

$$|\bar{r} - \bar{r}'| = \sqrt{r^2 + r'^2 - 2rr' \cos \theta} = r \sqrt{1 + 2 \frac{r'}{r} \cos \theta + \underbrace{\left(\frac{r'}{r}\right)^2}_{\approx 0}}$$

- Since $r' \ll r$ and $\sqrt{1 - 2x} \approx 1 - x$

$$|\bar{r} - \bar{r}'| \approx r - r' \cos \theta \quad (5.22a)$$

- Equivalently $|\bar{r} - \bar{r}'| \approx r - \bar{s} \cdot \bar{r}' \quad (5.22b)$



5.3 The Born Approximation

- Equation 5.22b implies that

$$\frac{e^{ik \cdot |\bar{r} - \bar{r}'|}}{|\bar{r} - \bar{r}'|} \simeq \frac{e^{ik \cdot r}}{r} e^{ik \cdot \bar{s} \cdot \bar{r}} \quad (5.23)$$

- The scattered field $U^{(S)}$ in equation 5.21 becomes

$$U^{(S)}[r\bar{s}, \omega] = \frac{e^{ik \cdot r}}{r} \int F[\bar{r}', \omega] \cdot U[\bar{r}', \omega] \cdot e^{-ik \cdot \bar{s} \cdot \bar{r}'} d^3 r' \quad (5.24)$$

- Equation 5.24 is generally still difficult to solve but a meaningful approximation can be made: the medium is weakly scattering = 1st Born Approximation.

- i.e. the field in the medium \simeq incident field $\Rightarrow U[r', \omega] = e^{ik \cdot \bar{s} \cdot \bar{r}'}$



5.3 The Born Approximation

- With $U[r', \omega] = e^{ik \cdot \bar{s} \cdot \bar{r}'}$, equation 5.24 becomes the Born Approximation:

$$U^{(S)}[\bar{s}, \bar{s}_0] = A \int F[r'] \cdot e^{-ik \cdot (\bar{s} - \bar{s}_0) \cdot \bar{r}'} d^3 r' \quad (5.25)$$

- Scattering vector:
 $\bar{q} = k(\bar{s} - \bar{s}_0) \rightarrow$ momentum transfer
- Note: $|\bar{p}| = |\bar{p}_0| \rightarrow$ elastic scattering
- Equation 5.25 becomes:

$$U^{(S)}[q] = A \int F[r'] \cdot e^{-i \cdot \bar{q} \cdot \bar{r}'} d^3 r' \quad (5.26)$$

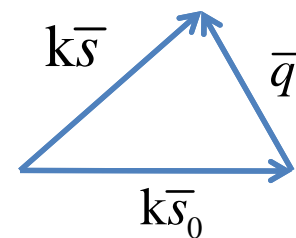



5.3 The Born Approximation

- Fourier Relationship:

$$\begin{cases} U^{(S)}[q] = \mathfrak{F}[F[\bar{r}']] \\ F[\bar{r}'] = \frac{1}{4\pi} k^2 \cdot (n^2[r'] - 1) \end{cases}$$

- F.T. is nice because it is easy to compute and bi-directional

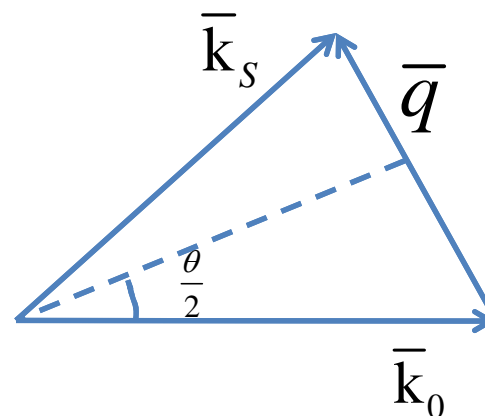
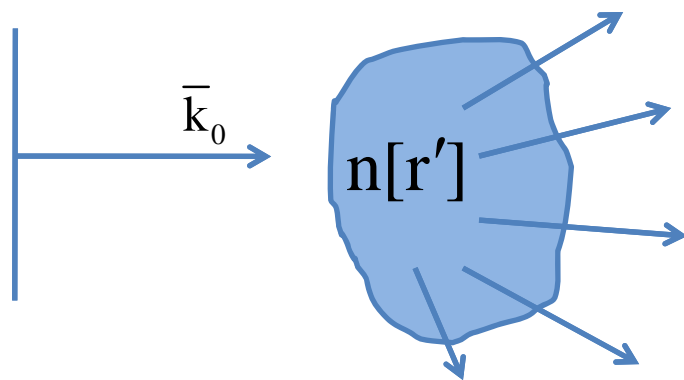

$$|\vec{q}| = 2k_0 \sin \frac{\theta}{2}$$

$\theta =$ scattering angle



5.3 The Born Approximation

- So measuring $I[\theta]$ we can get info about $n[r]$ because

$$F[\bar{r}'] = \mathfrak{F}[U[\bar{q}]] \quad (5.27)$$

- Historically the Born approximation was first used in neutron scattering and then in x-rays
- Recall dispersion relationship $n[\omega]$

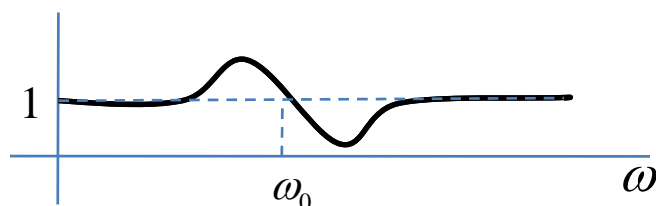

$\lim_{\omega \rightarrow \infty} n[\omega] = 1 \rightarrow$ for x rays, most materials are within Born Approx

- Scattering changes in tissue may report on cancer development!

Break 1



5.4 The Spatial Correlation Function

- $U^{(s)}(q) = A \int F(r') e^{-i\bar{q} \cdot \bar{r}'} d^3 r'$ provides the scattered field $U^{(s)}$

- The measured quantity is $|U^{(s)}|^2 = I^{(s)}$

$$I^{(s)} = |U^{(s)}|^2 = \mathfrak{F}[F(r)] \mathfrak{F}[F(r')]^*$$

- Recall correlation theorem: $GG^* = \mathfrak{F}[g \otimes g]$
- Product of Fourier Transformation equals \mathfrak{F} of correlation.
- $F(r') = \mathfrak{F}[U(\bar{g})]$ becomes:

$$I^{(s)} = \mathfrak{F}[F(r) \otimes F(r)] \quad \text{where} \quad C(r) = \int f(r') f(r'-r) d^3 r'$$

$$I^{(s)}(\bar{q}) = \int C(\bar{r}) e^{-i\bar{q} \cdot \bar{r}} d^3 \bar{r} \quad (4.28)$$



5.4 The Spatial Correlation Function

- $I^{(s)}(\bar{q}) = \int C(\bar{r}) e^{-i\bar{q}\cdot\bar{r}} d^3\bar{r}$ is another form of the Born approximation
- It connects measurable quantity $I^{(s)}(q)$ with the spatial correlation function $C(\bar{r})$.
- $I^{(s)}(q) = \int C(\bar{r}) e^{-i\bar{q}\cdot\bar{r}} d^3\bar{r}$ applies to both continuous and discrete media.

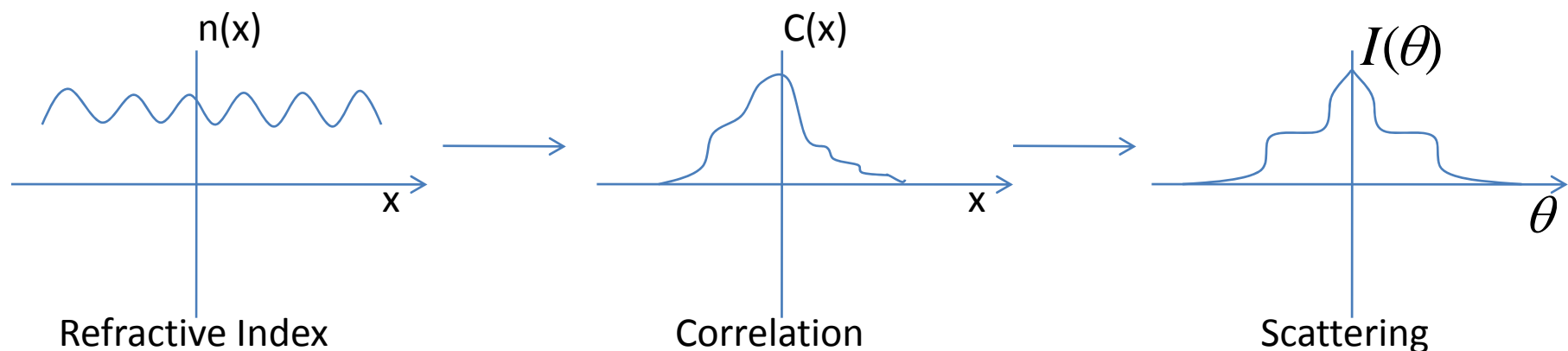



5.5 Single Particle Under Born Approximation

- Spherical particle $\left| \begin{array}{l} n(r) = n, \text{ if } |n| < R \\ 0, \text{ rest} \end{array} \right.$

- Correlation means the volume of overlaps between shifted “versions” of the function:

$$C(r) = \int f(r') f(r'-r) d^3 r' \quad (5.29)$$

- Use some geometry to show:

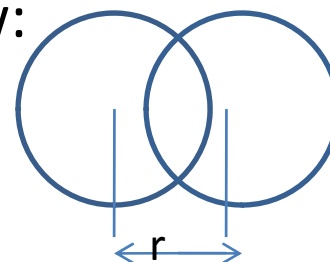
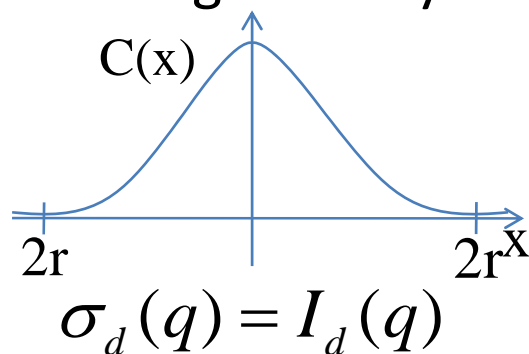

The overlap vol is 2x of the spherical “cap”

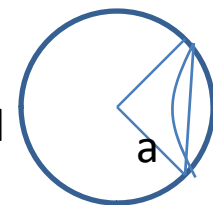

$$C(r) = A \left[1 - \frac{3r}{4R} + \frac{1}{16} \left(\frac{r}{R} \right)^3 \right] \quad (5.30)$$

- The differential cross section of such particle is $\sigma_d(q) \propto I_d(q)$



5.5 Single Particle Under Born Approximation

- Using: $I^{(s)}(q) = \int C(r) e^{-i\vec{q}\cdot\vec{r}} d^3\vec{r}$
- $\sigma_d(q) = Aq^4 a^6 [\sin(qa) - qa \cos(qa)]^2$ (5.31)
- $\sigma_d(q) = Aq^4 a^6 [\sin(qa) - qa \cos(qa)]^2$ is the solution for Rayleigh-Gans particles (Born approx. for spheres).
- Applies for $kd(n-1) \ll 1$
- Greater applicability than Rayleigh (Rayleigh is a particular case of Rayleigh-Gans, for $a \rightarrow 0$)



5.6 Ensemble of particles

- Example:

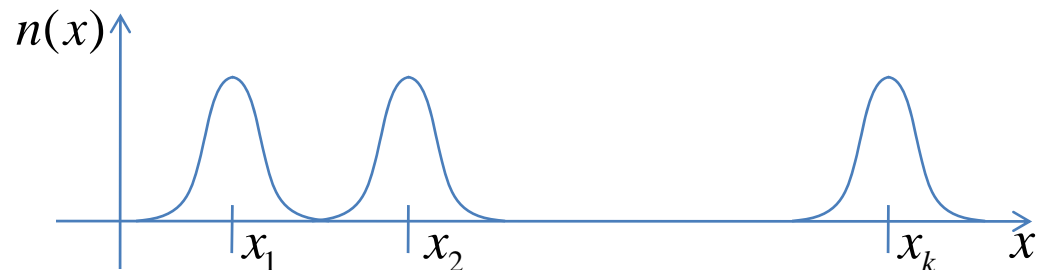

$$n(x) = f(x) \circledast \left[\sum_i \delta(x - x_i) \right] \rightarrow \text{Convolution} \quad (5.32)$$

- Particles have refractive index given by $f(x)$, but are distributed in space at positions $\delta(x - x_i)$
- Consider volume distribution of identical particles:

$$F(\mathbf{r}) = F_0(\mathbf{r}) \circledast \sum \delta(\bar{\mathbf{r}} - \bar{\mathbf{r}}_i) \quad (5.33)$$



5.6 Ensemble of particles

- Particles have refractive index given by $f(x)$, but are distributed in space at positions r_i

- Consider volume distribution of identical particles:

$$F(r) = F_0(r) \textcircled{\vee} \sum \delta(\bar{r} - \bar{r}_i) \quad (5.33)$$

- $F_0(r)$ = scattering potential a single particle.

- $\textcircled{\vee}$ convolution

- The scattered field is (Eq. 5.26)

$$\begin{aligned} U^{(s)}(g) &= \mathfrak{I}[F_0(\bar{r}) \textcircled{\vee} \sum \delta(\bar{r} - \bar{r}_i)] \quad (5.34) \\ &= \underbrace{\mathfrak{I}[F_0(\bar{r})]}_{F(q)} \underbrace{\mathfrak{I}[\sum_i \delta(\bar{r} - \bar{r}_i)]}_{S(q)} \end{aligned}$$



5.6 Ensemble of particles

- The scattered field is (Eq. 5.26)

$$\begin{aligned} U^{(s)}(\mathbf{g}) &= \mathfrak{F}[F_0(\bar{\mathbf{r}}) \odot \sum_i \delta(\bar{\mathbf{r}} - \bar{\mathbf{r}}_i)] && (5.34) \\ &= \underbrace{\mathfrak{F}[F_0(\bar{\mathbf{r}})]}_{F(q)} \underbrace{\mathfrak{F}[\sum_i \delta(\bar{\mathbf{r}} - \bar{\mathbf{r}}_i)]}_{S(q)} \end{aligned}$$

$F(q)$ = Form factor
= Describe the scattering from one particle

$S(q)$ = Structure factor – interference
= Defines the arrangement of scattering



5.6 Ensemble of particles

- Similarly

- a) Yang experiment

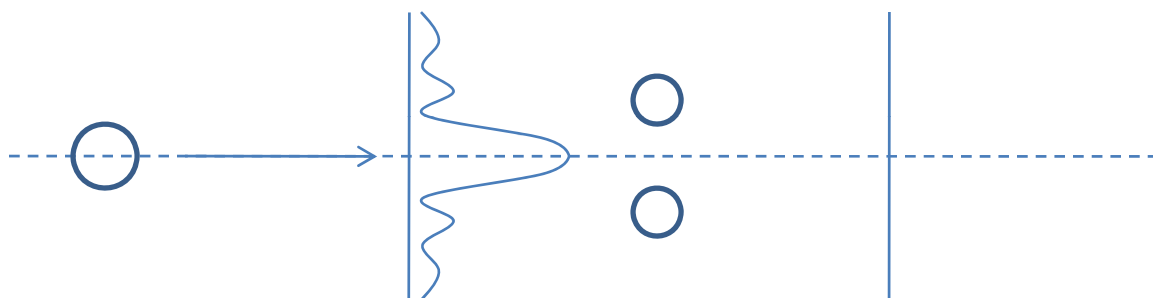

- b) X-ray scattering on crystals

- each scattering is Rayleigh → isotropic in angle (atom)
 - Structure factor provides info about lattice



5.7 Mie Scattering

- Provides exact solution σ_s for spherical particles of arbitrary refractive index and size.

$$\sigma_s = \pi a^2 \frac{2}{\alpha^2} \sum_{n=1}^{\infty} (2n+1) (|a_n|^2 + |b_n|^2) \quad (5.35)$$

with a_n, b_n = Mie coefficients = complicated functions of

- The above equation is an infinite series
- Converges slower for larger particles
- Computes routines easily available

$$\alpha = ka$$

$$\beta = k \frac{n}{n_0} a$$

5.7 Mie Scattering

- Scattering Efficiency

$$Q = \frac{\sigma_s}{\pi a^2} \quad (5.36)$$

- Scattering from large particles:

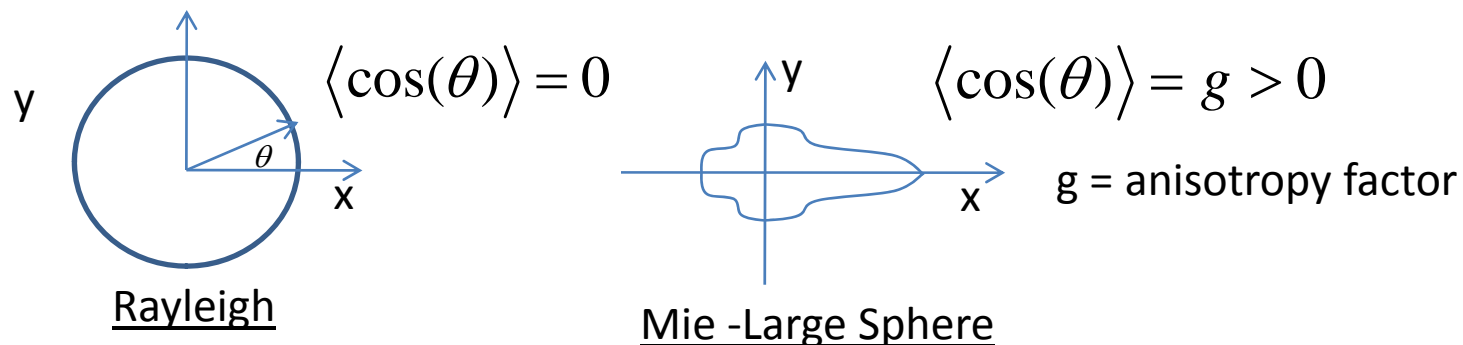

- Although Mie is restricted to spheres, is heavily used for tissue modeling
- Mie takes into account multiple bounces inside the particle.



5.8 Multiple Light Scattering

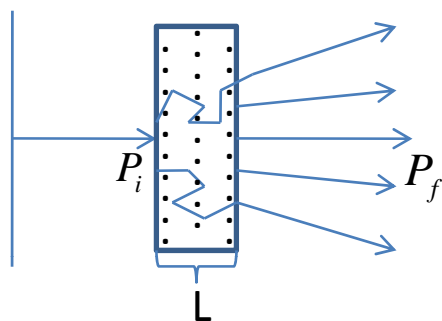

- Attenuation through scattering medias is quantified by the scattering mean free path:

$$l_s = \frac{1}{N\sigma_s} \quad (5.37)$$

- N = Concentration of particles [m^{-3}]
- Scattering Coefficient: $\mu = \frac{1}{l_s} = N\sigma_s$

- The power left unscattered upon passing through the medium:

$$P_f = P_i e^{-\mu_s L} \quad (5.38)$$

= Lambert-Beer



5.8 Multiple Light Scattering

- Transport mean free path:

$$l_t = \frac{l_s}{1-g} \quad g = \langle \cos(\theta) \rangle \quad (5.39)$$

= average of scatter angle

- l_t is renormalizing l_s ; takes into account the directional scattering of large particles.
- Note:

$g \in (0.75; 0.99)$ for tissue!

$\frac{l_t}{l_s} \in (10; 40)$ -important factor



5.9 The Transport Equation

- The multiple scattering regime is not tractable for the general case.
- For high concentration of particles some useful approximations can be made.
- Photon random walk model \rightarrow borrowed from nuclear reaction theory \rightarrow Transport Equation = Balance of Energy.

$\varphi(\vec{r}, \Omega, t) =$
= angular flux

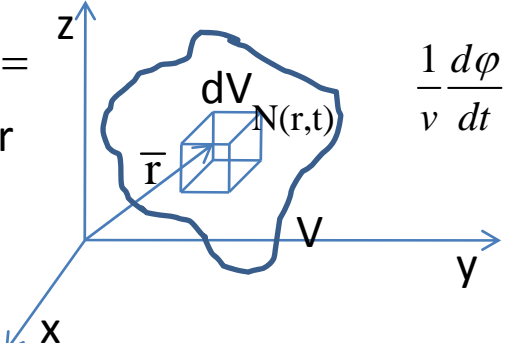

$$\frac{1}{v} \frac{d\varphi}{dt} + \underbrace{\bar{\Omega} \bar{\nabla} \varphi}_{\text{Leakage out of } dV} + \underbrace{\mu \varphi(\bar{r}, \Omega, t)}_{\text{Loss due to scatt}} - \underbrace{\int_{4\pi} [\mu_s(\bar{\Omega}' \rightarrow \Omega) \varphi(\bar{r}, \Omega', t)] d\Omega'}_{\text{Scattered into direction } \Omega} = \underbrace{S(\bar{r}, \bar{\Omega}, t)}_{\text{Source}} \quad (5.40)$$

- Even this simple equation is typically solved numerically.
- One more approximation \rightarrow analytic solutions.



5.10 The Diffusion Approximation

- Integrate both sides of the equation $S(\bar{r}, \bar{\Omega}, t)$ with respect to solid angle Ω
- $$\frac{1}{v} \frac{d\phi}{dt} + \bar{\nabla} \bar{J}(\bar{r}, t) + \mu \phi(\bar{r}, t) = \mu_s \phi(\bar{r}, t) + S(\bar{r}, t) \quad (5.41)$$

$$\phi = \text{photon flux} = \int_{4\pi} \varphi(\bar{r}, \bar{R}, t) d\bar{\Omega} \quad \bar{J} = \text{current} = \int_{4\pi} \bar{\Omega} \varphi(\bar{r}, \bar{R}, t) d\bar{\Omega}$$



5.10 The Diffusion Approximation

- Diffusion Approximation:

- Assume the angular flux is only linearly anisotropic.

$$\phi(\bar{r}, \bar{\Omega}, t) \approx \frac{1}{4\pi} \phi(\bar{r}, t) + \frac{3}{4\pi} \bar{J}(\bar{r}, t) \cdot \bar{\Omega} \quad (5.42)$$

- If $\frac{1}{|\bar{J}|} \frac{\partial \bar{J}}{\partial t} \ll v\mu_t =$ slow variation of \bar{J} , an equation that relates \bar{J} and ϕ can be derived:

$$\bar{J}(\bar{r}, t) = -\frac{1}{3\mu_t} \nabla \phi(\bar{r}, t) = -D(\bar{r}) \bar{\nabla} \phi(\bar{r}, t) \quad (5.43)$$

$$\mu t = \frac{1}{l_t}; l_t = \frac{l_s}{1-g}; g = \langle \Omega \cdot \Omega' \rangle = \text{average cosine.}$$

$D =$ Photon diffusion Coefficient

- Eq 5.43 is Flick's Law



5.10 The Diffusion Approximation

- The diffusion equation can be derived:

$$\frac{1}{v} \frac{d\phi}{dt} - \nabla[D(r)\nabla\phi(\bar{r}, t)] + \mu_a(r)\phi(\bar{r}, t) = S(\bar{r}, t) \quad (5.44)$$

- Equation in only one variable: $\phi = vr(\bar{r}, t) =$ photon flux

$v =$ photon velocity

$n =$ photon density [m^{-3}]

- $\mu_a =$ absorption coefficient

- For homogeneous medium and no absorption:

$$\frac{d\phi(\bar{r}, t)}{dt} - vD\nabla^2\phi(\bar{r}, t) = vS(r, t) \quad (5.45)$$



Time resolved equation



5.10 The Diffusion Approximation

- Diffusion equation often used for light-tissue introduction
- Applicability: $L \gg l_s \Leftrightarrow$ many scattering events
 $\mu_a \ll \mu_s \rightarrow$ absorption not too high
- ϕ = measurable quantity
- Diffusion model gives insight into the medium/tissue
- Measurable parameters: μ_s , μ_a , g , etc



5.11 Solutions of the Diffusion Equation

- Slab of thickness d :
- Power reflected/ transmitted:

$$P_R(r, s, d) = A \cdot s^{-\frac{5}{2}} e^{-\mu_a s} e^{-\frac{r^2}{4Ds}} f_R(d, z_e)$$

$$P_T(r, s, d) = A \cdot s^{-\frac{5}{2}} e^{-\mu_a s} e^{-\frac{r^2}{4Ds}} f_T(d, z_e)$$

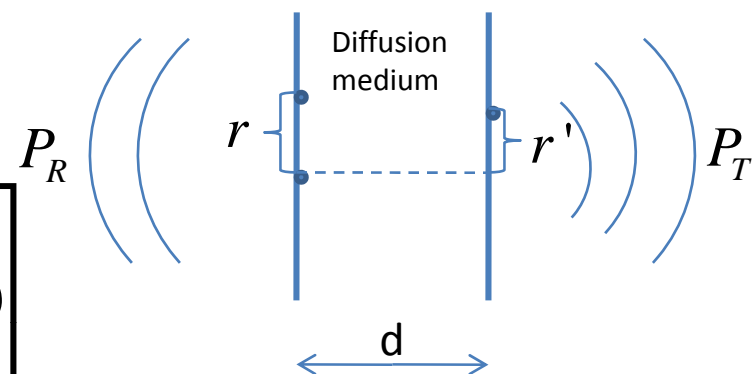

(5.46)

- With: $s = \text{path-length} = vt$
 $z_e = \text{extrapolated length} \rightarrow \text{boundary condition}$
- f_R, f_T reflection and transmission functions
- Laser pulse investigation has been used for tissue
- Stationary investigation also used \rightarrow spatially resolved



5.12 Diffusion of Light in Tissue

- Tissue is a highly scattering medium; direction & polarization are randomized.
 - Typical values: $l_s = 100\mu\text{m}$, $g \approx 0.9$
 - Measurable quantities:
 - μ_a = absorption factor
 - g = anisotropy factor
 - μ_s = scattering coefficient
 - Reflection and geometry is suitable for in vivo diagnostics
- a) Time resolved:

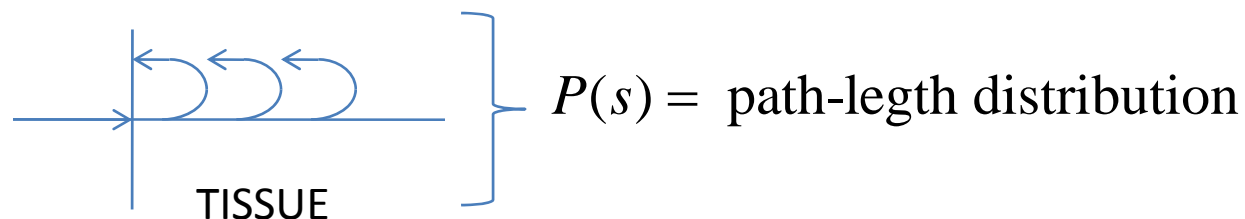



5.12 Diffusion of Light in Tissue

a) Time resolved:

- Used with femtosecond laser and LCI
- $P(s)$ is a measurable tissue characterization

b) Spatially resolved:

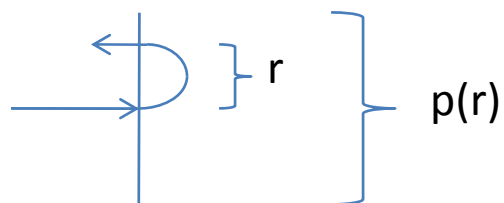

▪ Note:

- Semi-infinite medium model is heavily used.
- If there is refractive index at boundary, not quite continuous angular distribution.

Break 2