

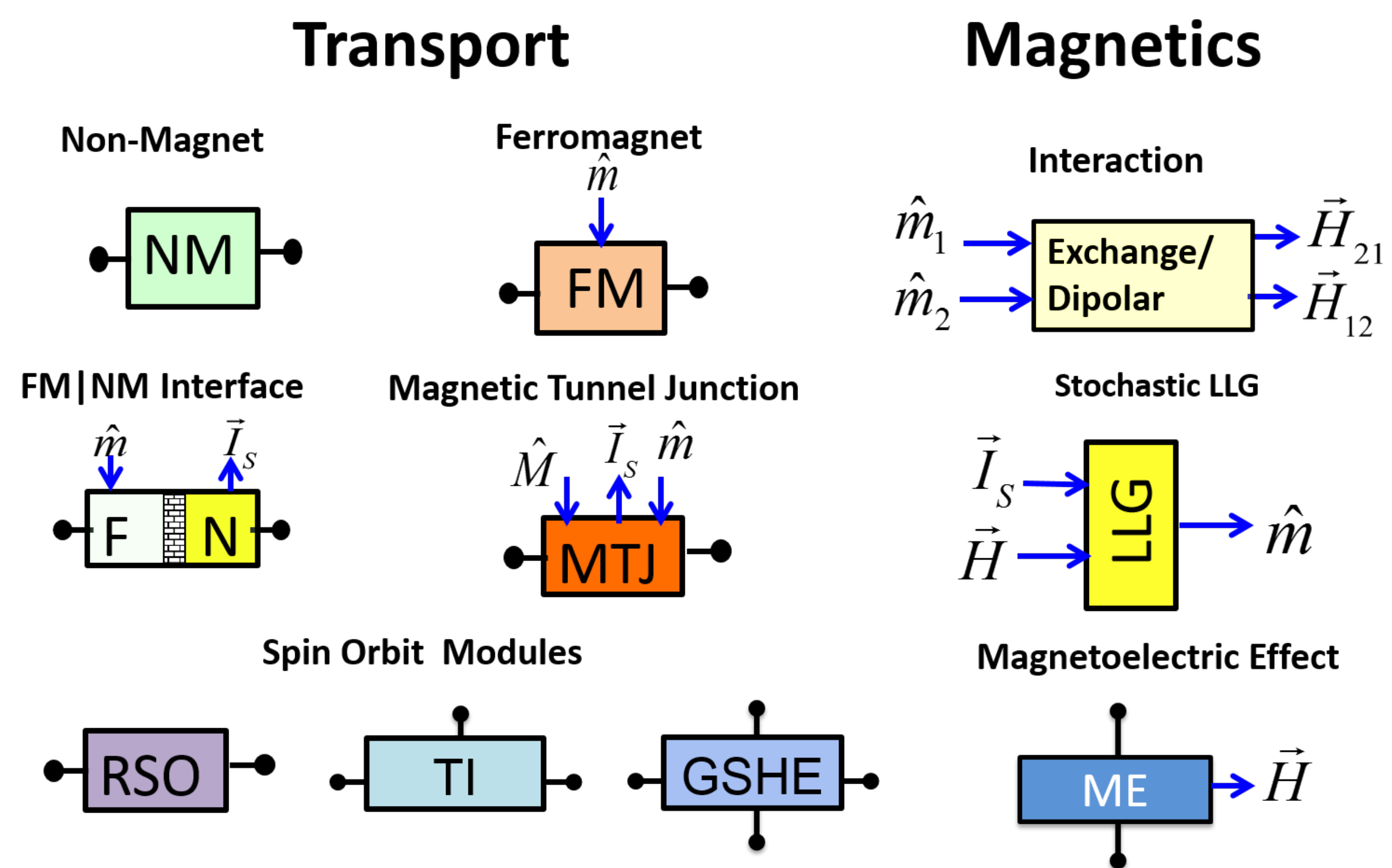

Modular Approach to Spintronics

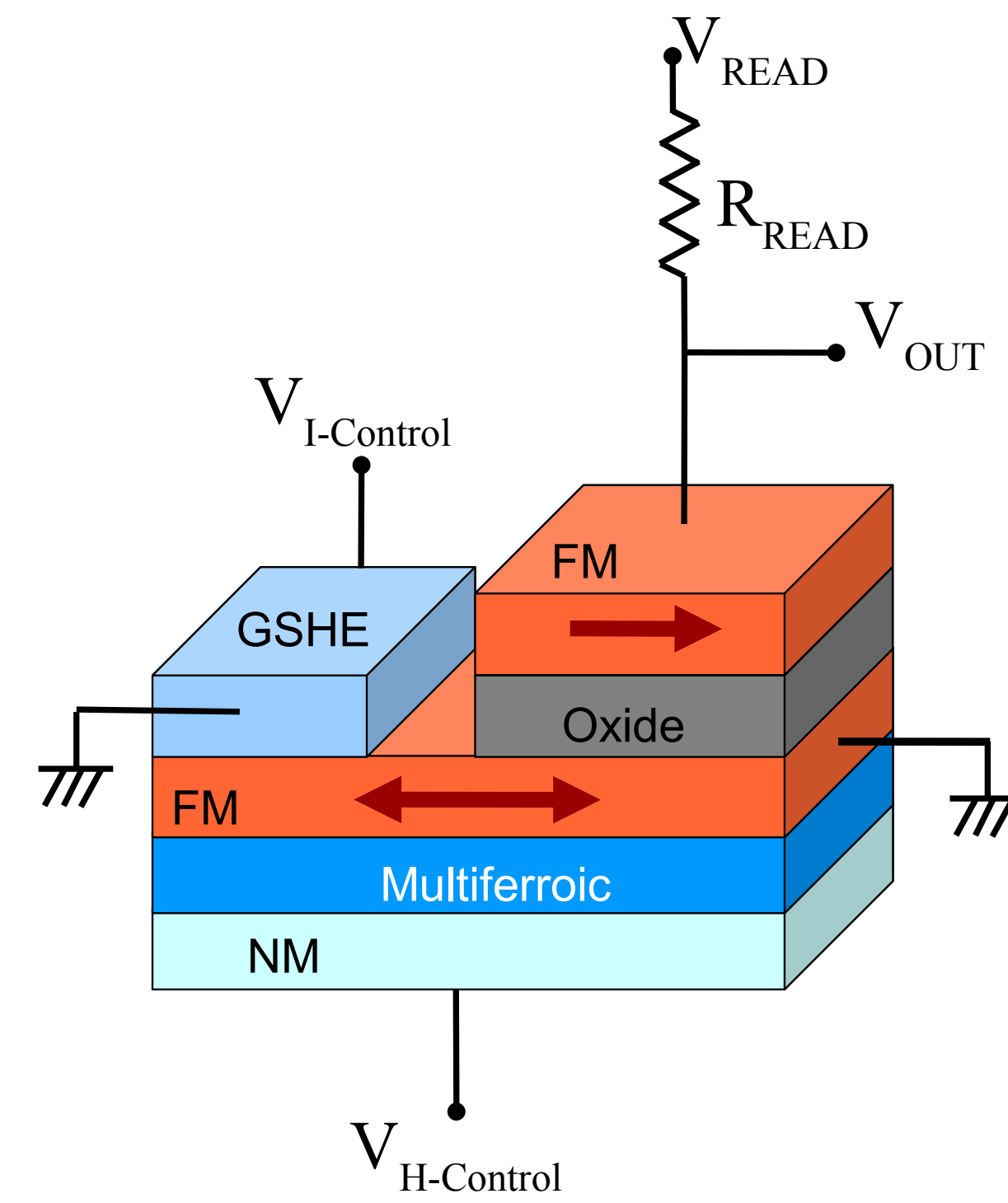

Oscillator Design



Spin-Circuit Model

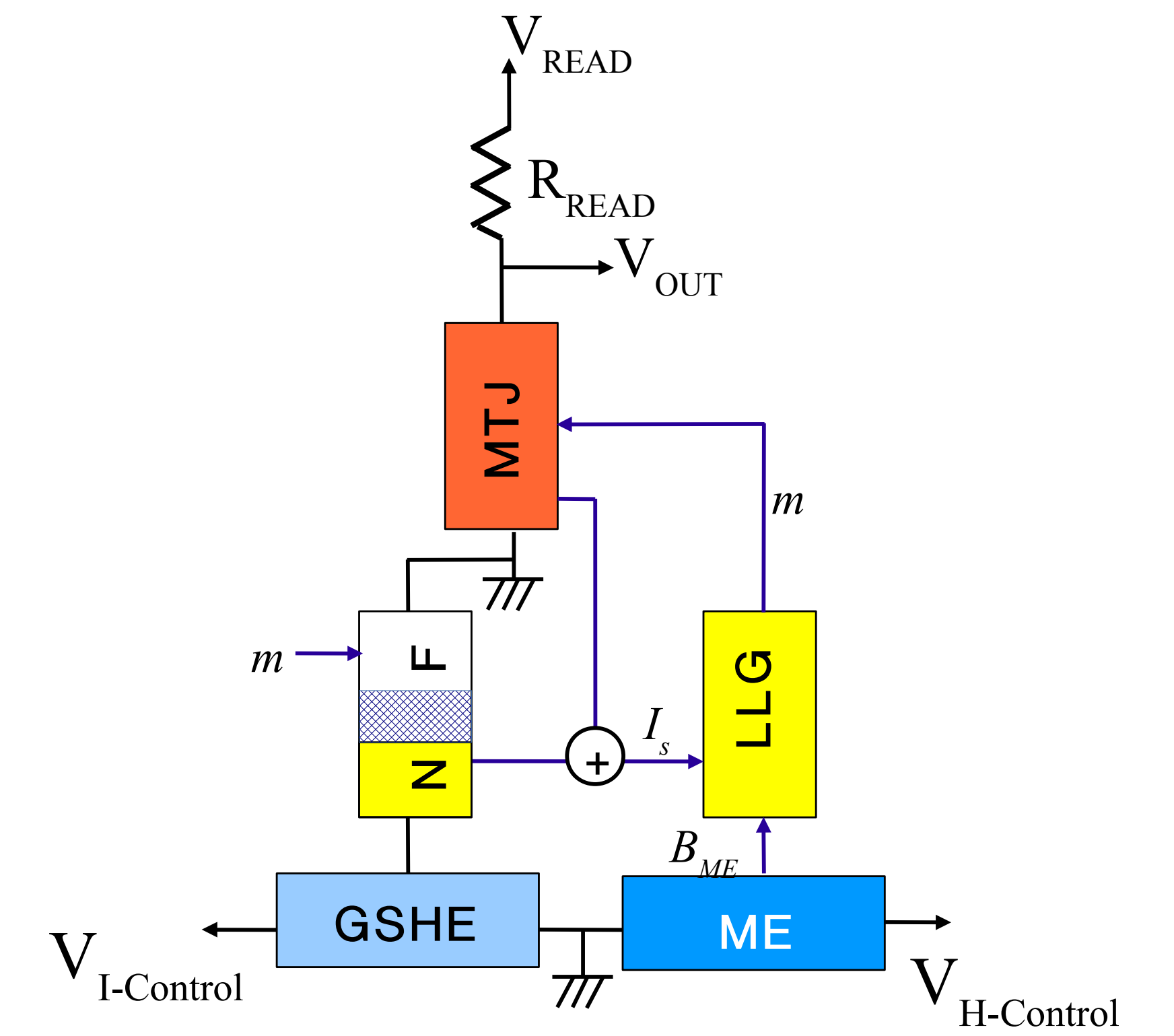

Dual Device Control

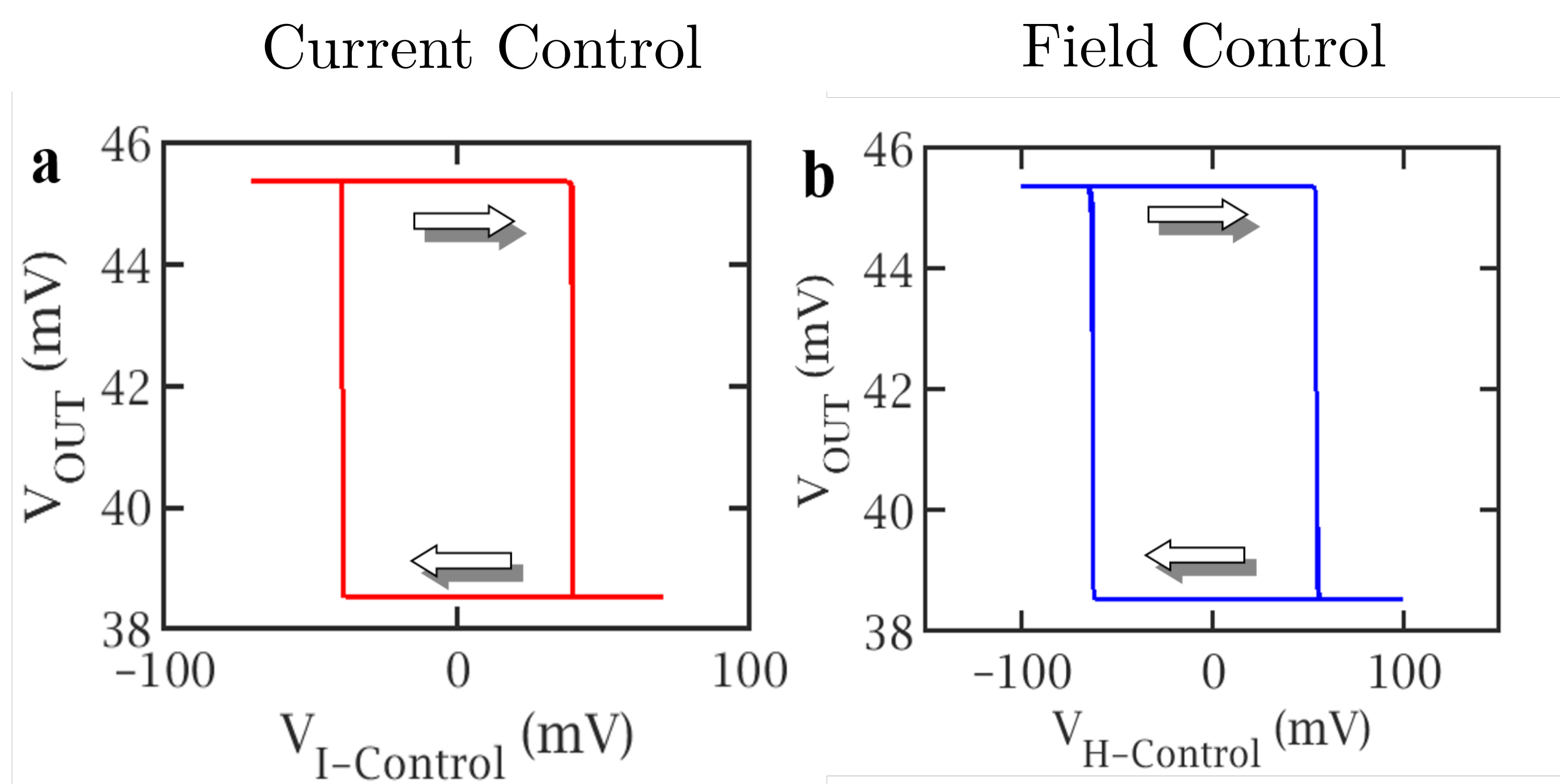

Device Operation

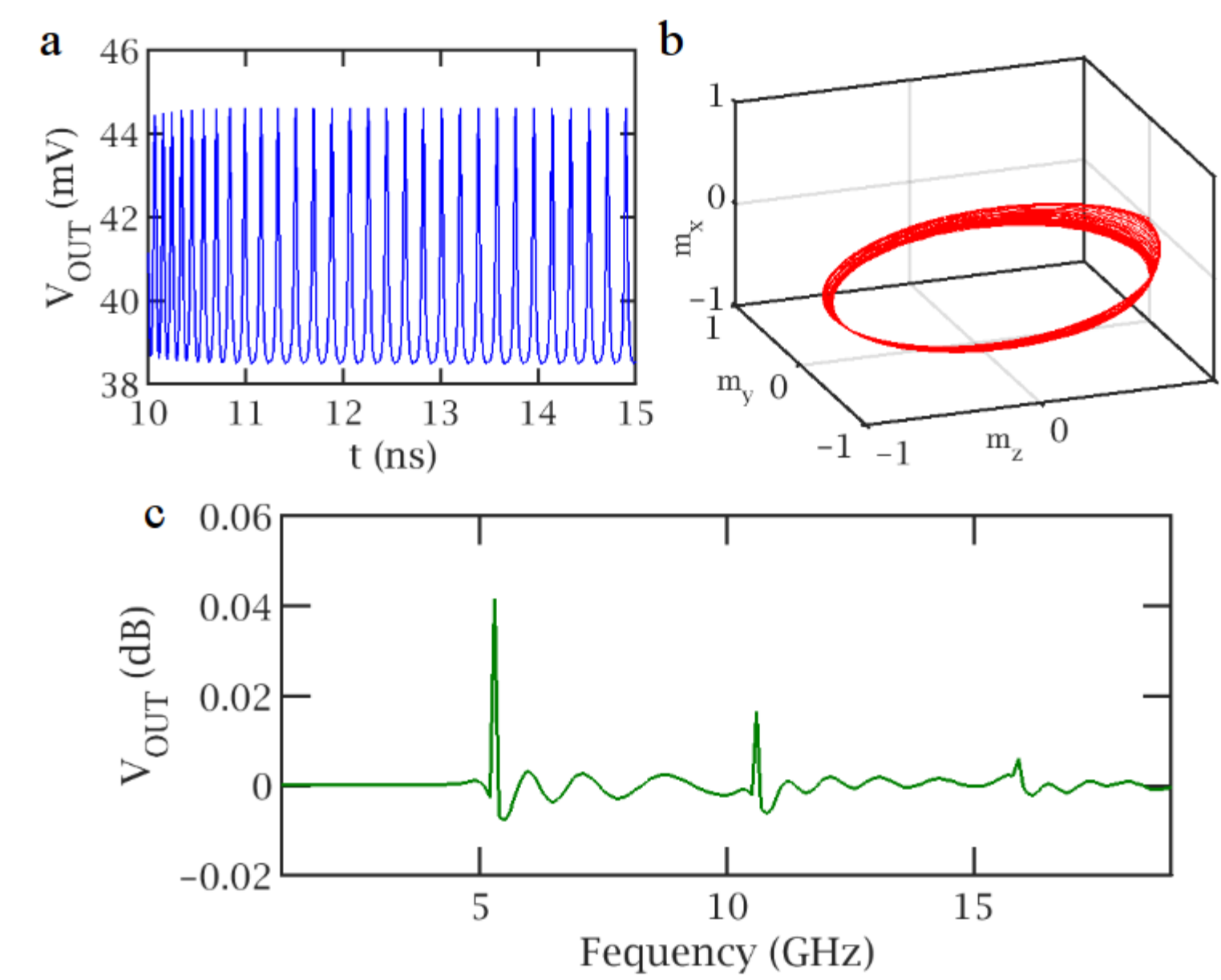

Dual Frequency Control

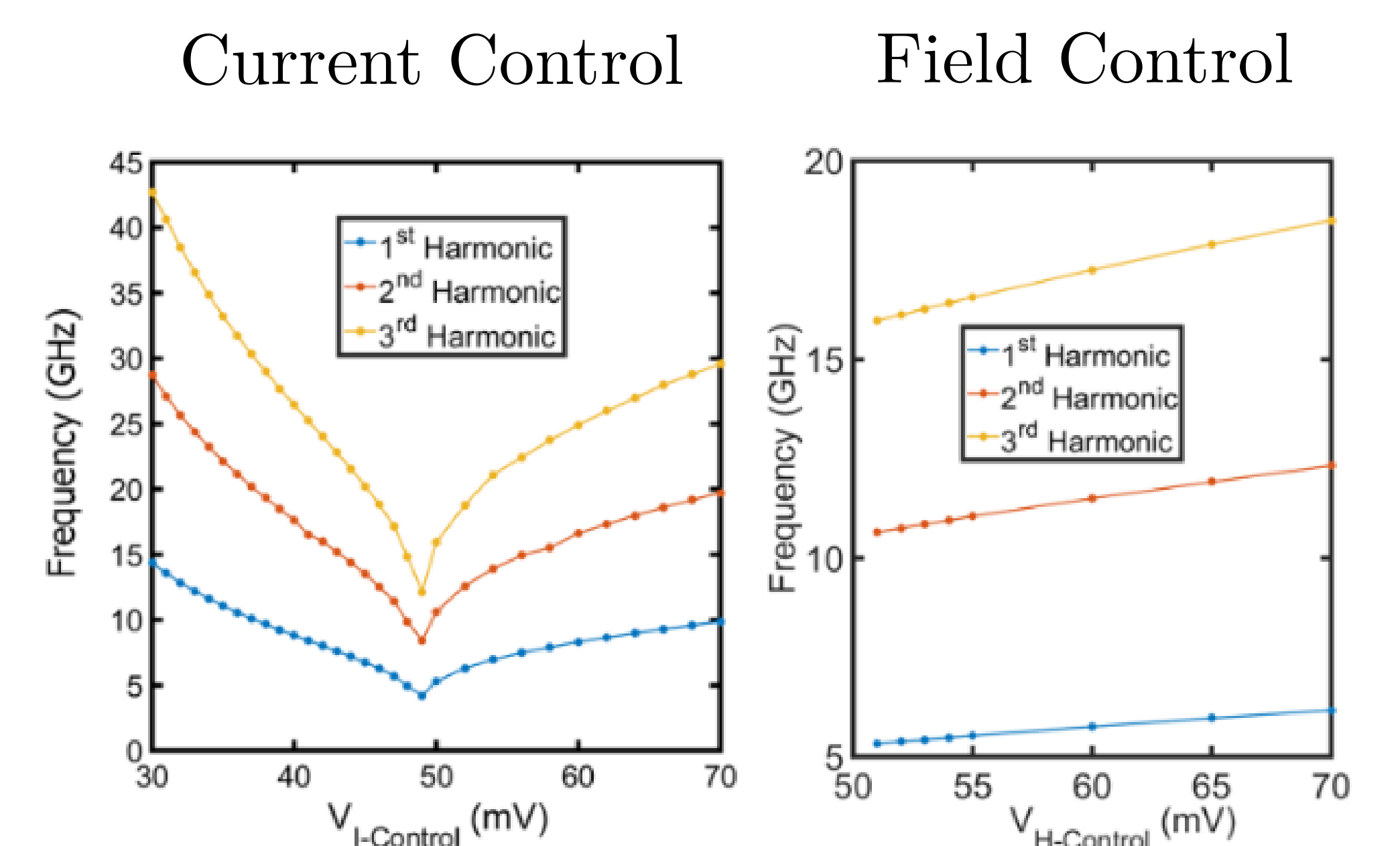

Magneto-Electric Effect

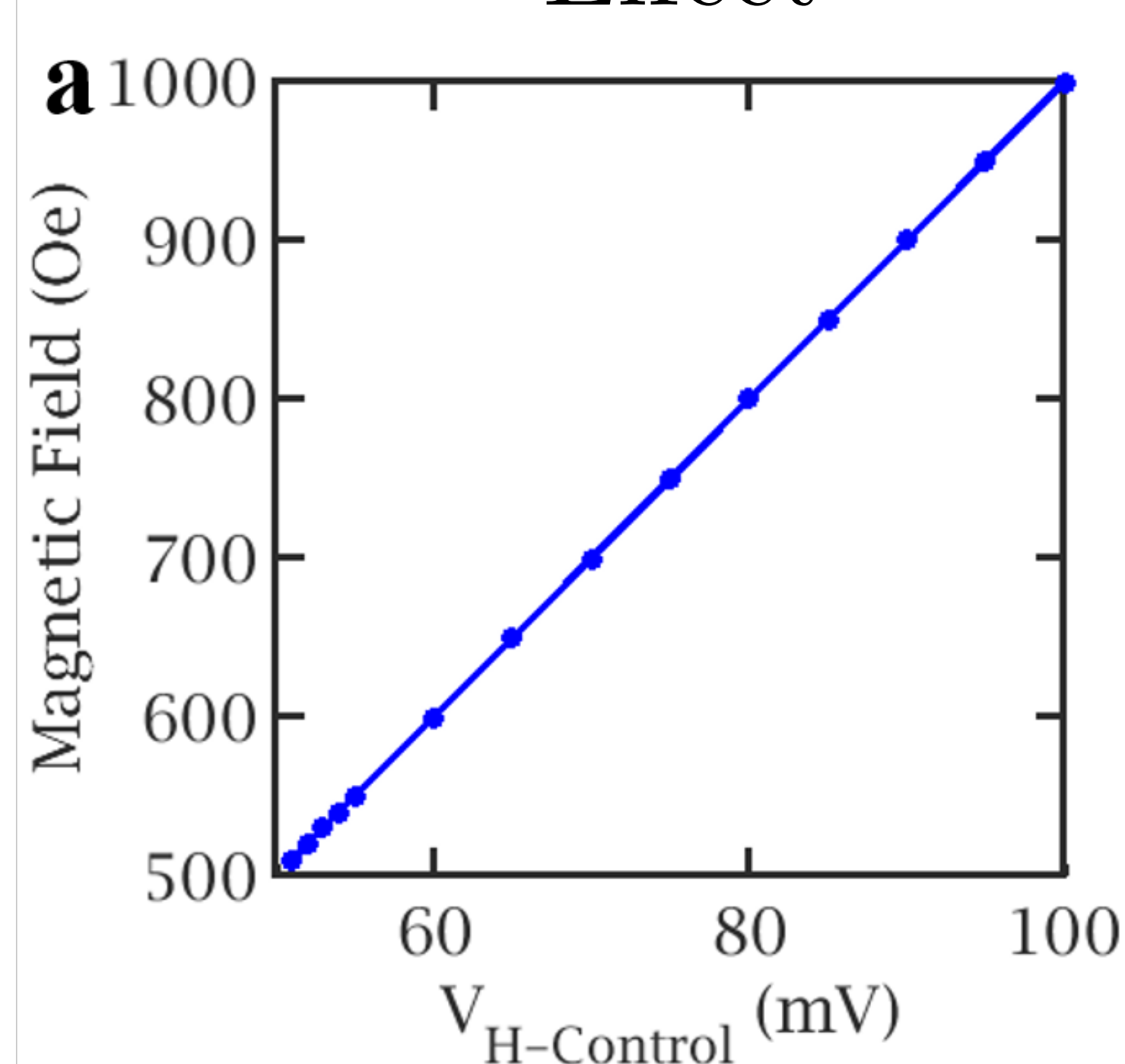

Phase Noise Reduction By Injection Locking \rightarrow Dual Control

